

Perzeptiver Farbsensor PCS-II

Perceptive Color Sensor PCS-II



Silicann Systems GmbH
Schillerplatz 10
18055 Rostock

Tel: +49 (381) 3676412-0
Fax: +49 (381) 3676412-9

www.silicann.com

Elektrische Anschlüsse/ *Electrical interfaces*

Die elektrischen Anschlüsse des PCS-II zeigt Fig. 1./
 The electrical connections of the PCS-II shows Fig. 1.

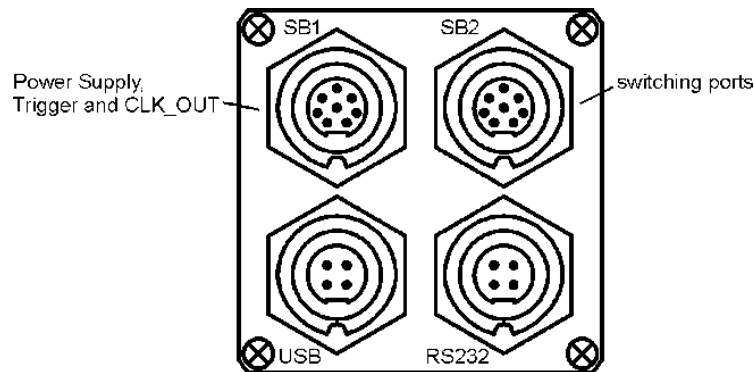

Fig. 1: Elektrische Anschlüsse am Sensor/ *Electrical interfaces*

Tab. I: Bedeutung der Signale an Sensorbuchse SBI/ *Sensor connector SBI pin description*

| Pin (color) | Name | Bedeutung/ <i>Description</i> |
|--------------------------|-------------------|--|
| 1 (weiß/ <i>white</i>) | N.C.*/ OUT 0** | OUT 0** |
| 2 (braun/ <i>brown</i>) | N.C.*/ OUT 1** | OUT 1** |
| 3 (grün/ <i>green</i>) | TRG 1 | Einspeisung eines Triggerimpulses zur ext. Synchronisation/ <i>trigger signal input for external synchronization purposes</i> |
| 4 (gelb/ <i>yellow</i>) | TRG 0 | <ol style="list-style-type: none"> Eingang zur Aktualisierung der Sensorausgänge (steigende Flanke) im „EXTERN“ Modus/ <i>input for updating the sensor outputs (rising edge) in “EXTERN” mode</i> Eingang für Triggergesteuerte Farbsequenz im „TRIGG. SEQU.“ Modus (steigende Flanke)/ <i>input for trigger controlled color sequence in “TRIGG. SEQU.” mode (rising edge)</i> Eingang für zeitgesteuerte Farbsequenzerkennung im „TIMED SEQU.“ Modus (steigende Flanke)/ <i>input for starting timed color sequence in “TIMED SEQU.” mode (rising edge)</i> Eingang für externes Teach-In im „EXT. TEACH“ Modus (steigende Flanke)/ <i>input for external triggered Teach-In in “EXT. TEACH” mode (rising edge)</i> |
| 5 (grau/ <i>gray</i>) | CLK | <ul style="list-style-type: none"> zusätzl. Schaltausgang (Kanal) 0/ <i>additional switching output (Channel) 0</i> Ausgang zur Synchronisation einer externen Zusatzbeleuchtung oder weiterer Sensoren/ <i>output signal for synchronization of an additional external light source or an additional sensor</i> Ausgang für allgemeine Zwecke/ <i>General purpose output</i> |
| 6 (rosa/ <i>pink</i>) | N.C.*/ OUT 2** | OUT 2** |
| 7 (blau/ <i>blue</i>) | GND | Masseanschluss/ <i>Ground</i> |
| 8 (rot/ <i>red</i>) | +U _B | Betriebsspannung/ <i>power supply</i> |

* / ** siehe Seite 9 / *see page 9*

Tab. 2: Signalbedeutung SB2/ *pin description SB2*

| Pin (Farbe/ <i>color</i>) | Bedeutung/ <i>Description</i> |
|----------------------------|-------------------------------|
| 1 (weiß/ <i>white</i>) | OUT 1 |
| 2 (braun/ <i>brown</i>) | OUT 2 |
| 3 (grün/ <i>green</i>) | OUT 3 |
| 4 (gelb/ <i>yellow</i>) | OUT 4 |
| 5 (grau/ <i>gray</i>) | OUT 5 |
| 6 (rosa/ <i>pink</i>) | OUT 6 |
| 7 (blau/ <i>blue</i>) | OUT 7 |
| 8 (rot/ <i>red</i>) | OUT 0 |

Technische Daten/ *Technical Data*

Tab. 3: Elektrische Daten/ *Electrical Data*

| | |
|---|---|
| Fotodetektor/ <i>Photo detector</i> | Dreibereichsfotodiode/ <i>Three range photo diode</i> |
| Verstärkungsstufen/ <i>Gain steps</i> | 1, 5, 25, 100 |
| A/D Umsetzung/ <i>A/D Conversion</i> | 3 x 12 Bit |
| Fremdlichtkompensation/ <i>Ambient light compensation</i> | Dynamisch, Abschaltbar/ <i>Dynamic, Can be switched off</i> |
| Objektbeleuchtung/ <i>Object illumination</i> | <ul style="list-style-type: none"> • Weißlicht-LED/ <i>White light LED</i> • Einstellbare Helligkeit/ <i>Adjustable brightness</i> • Abschaltbar/ <i>Can be switched off</i> |
| Anschlüsse/ <i>Connectors</i> | <ul style="list-style-type: none"> • RS232 (max. 115 kBit/s) • USB • 8 Schaltausgänge/ <i>8 switching outputs</i> • 1 Steuerausgang/ <i>1 control output</i> • 2 Steuereingänge/ <i>2 control inputs</i> |
| Farbauflösung/ <i>Color resolution (L*a*b*)</i> | $DE_{Lab} \leq 1$ |
| Ansprechzeit/ <i>Response time</i> | $\geq 90 \mu s$ |
| Schutzart/ <i>Protection standard</i> | IP65 |
| Stromversorgung/ <i>Power supply</i> | 18...28 VDC, max. 500mA |
| Gehäusetemperatur im Betrieb/ <i>Case temperature for operation</i> | -10...55°C |

Tab. 4: Funktionen/ *Functionality*

| | |
|---|--|
| Farbraummodi/ <i>Color space modes</i> | Körperfarben/ <i>Non-self-shining objects</i> <ul style="list-style-type: none"> • XYZ • xyY • $L_{99}a_{99}b_{99}$ • $L^*a^*b^*$ • $L^*u^*v^*$ Selbstleuchter/ <i>Self-shining objects</i> <ul style="list-style-type: none"> • XYZ • xyY • $u^*v^*L^*$ |
| Ausgangshaltezeit/ <i>Output hold time</i> | 0...65535 ms |
| Hysterese/ <i>Hysteresis</i> | 0...255% |
| Farbspeicher (Farbklassen)/ <i>Color memory cells (color classes)</i> | bis zu/ <i>up to</i> 255 |
| Farbverarbeitungsmodi/ <i>Color processing modes</i> | <ul style="list-style-type: none"> • Farberkennung/ <i>Color recognition</i> (d.h. Prüfung, ob sich gemessene Farbe innerhalb einer festgelegten Toleranz befindet/ <i>i.e. Check, if measured color matches a color sample within an adjustable tolerance</i>) |

| | |
|--------------------------------------|---|
| | <ul style="list-style-type: none"> • Farbklassifikation/ <i>Color classification</i> (d.h. Zuordnung der gemessenen Farbe zur besten passenden Farbklasse/ <i>i.e. Matching of measured color to the most similar color class</i>) |
| Betriebsmodi/ <i>Operating modes</i> | <ul style="list-style-type: none"> • Externe Triggerung/ <i>External triggering</i> • Fremdsynchronisation/ <i>External synchronization</i> • Selbstleuchter/ <i>Self-shining objects</i> • Körperfarben/ <i>Non-self-shining objects</i> • Farbgruppenbildung/ <i>Color grouping</i> • Farbsequenzerkennung/ <i>Color sequence recognition</i> |
| PC Software | <ul style="list-style-type: none"> • Sensorparametrierung/ <i>Parameterizes the sensor</i> • Signaldarstellung in Farbdigrammen/ <i>Visualization of signals in color diagrams</i> • Teach-In der Farbmuster/ <i>Teach-In of color patterns</i> • Anzeige von Farbwerten/ <i>Display of color values</i> • Firmware Update/ <i>Firmware update</i> • LabVIEW® Treiber/ <i>LabVIEW® driver</i> • Windows® DLL |

Tab. 5: Optische Daten/ *Optical Data*

| | |
|---|---|
| Messsignaleinkopplung/ <i>Coupling in measurement signal path</i> | per Lichtwellenleiter/ <i>Via optical fiber</i> |
| Objektbeleuchtung/ <i>Object illumination path</i> | per Lichtwellenleiter/ <i>Via optical fiber</i> |
| Lichtquelle/ <i>Illuminant</i> | Weißlicht-LED/ <i>White light LED</i> |
| Optische Dynamic/ <i>Optical dynamic</i> | 0...8 µW |

Tab. 6: Mechanische Daten/ *Mechanical Data*

| | |
|--|--|
| Gehäusematerial/ <i>Housing material</i> | Alu, eloxiert/ <i>Aluminum, anodized</i> |
| Maße/ <i>Housing size</i> | 89,7x36x36 mm ³ |
| Gewicht/ <i>Weight</i> | ca./ <i>approx.</i> 150 g |
| Faseranschluss/ <i>Fiber Connector</i> | M18x1 |

Zeichnungen/ *Drawings*

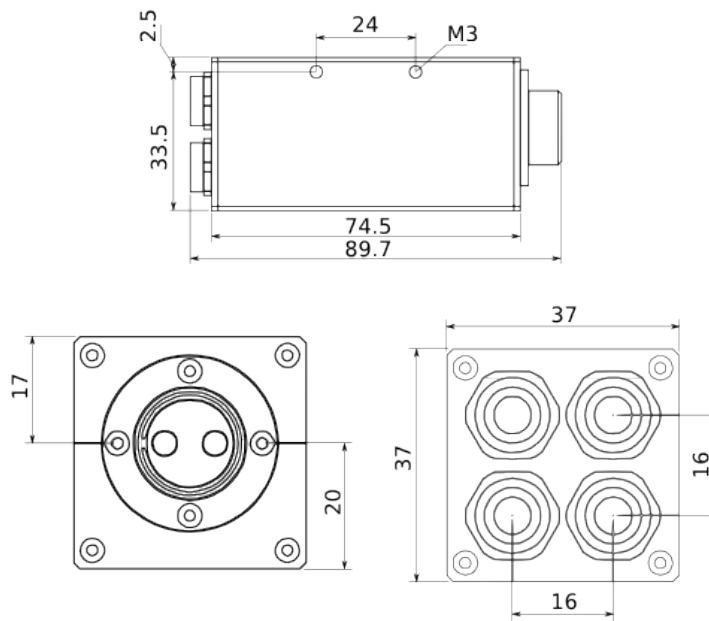

Elektrische Anschlüsse/ *Electrical connectors*

Die Zählweise für die PINs der 4-poligen Rundbuchse können Fig. 2 entnommen werden./
 The counting order of the 4-pin round connectors is shown in Fig. 2.

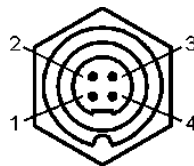

Fig. 2: Zählweise der 4-poligen Rundbuchse/ *Counting order of the 4-pin round connectors*

Tab. 7: RS232

| Pin | Spezifikation/ <i>Specification</i> |
|----------|-------------------------------------|
| 1 (GND) | 0 V |
| 2 (TXD) | -5 V...+5 V |
| 3 (RXD) | -5 V...+5 V |
| 4 (N.C.) | - |

Tab. 8: RS232 Parameter/ *Parameters*

| Parameter/ <i>Parameters</i> | Wert/ <i>Value</i> |
|------------------------------|--------------------|
| Baud rate | 9.600...115.200 |
| Data bits | 8 |
| Parity | no |
| Stop bits | 1 |
| Flow control | no |

Hinweis/ *Hint*:

Die Baud Rate der RS232 Schnittstelle ist auf 28800 voreingestellt./
 The baud rate of the RS232 interface is pre-set to 28800.

Tab. 9: USB

| Pin | Spezifikation/ <i>Specification</i> | Bedeutung/ <i>Description</i> |
|----------|-------------------------------------|-------------------------------|
| 1 (GND) | 0 V | GND (Schwarz/ <i>black</i>) |
| 2 (VBUS) | +5 V | VBUS (Rot/ <i>red</i>) |
| 3 (D-) | -400 mV | D- (Weiß/ <i>white</i>) |
| 4 (D+) | +400 mV | D+ (Grün/ <i>green</i>) |

Die Zählweise für die PINs der 8-poligen Rundbuchse können Fig. 3 entnommen werden./
 The counting order of the 8-pin round connectors SB1 and SB2 is shown in Fig. 3.

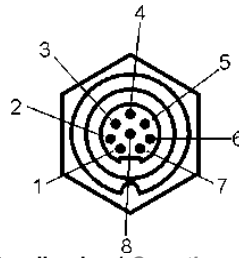

Fig. 3: Zählweise der 8-poligen Rundbuchse/ Counting order of the 8-pin round connector

Tab. 10: Spezifikation Sensorbuchse SB1/ Specification sensor connector SB1

| Pin | Spezifikation/ <i>Specification</i> |
|--|---|
| 1 (N.C.)* / (OUT 0)** | -*/ Gegentakt/ <i>Push-Pull</i> , LOW: 0V; HIGH: +U _B -1V; max. 100 mA** |
| 2 (N.C.)* / (OUT 1)** | -*/ Gegentakt/ <i>Push-Pull</i> , LOW: 0V; HIGH: +U _B -1V; max. 100 mA** |
| 3 (IN1) (Flankengesteuert/ <i>edge triggered</i>) | LOW: 0...3V; HIGH: 18...28V |
| 4 (IN0) (Flankengesteuert/ <i>edge triggered</i>) | LOW: 0...3V; HIGH: 18...28V |
| 5 (CLK_OUT) | LOW: 0V; HIGH: +U _B -1V; max. 4 mA |
| 6 (N.C.)* / (OUT 2)** | -*/ Gegentakt/ <i>Push-Pull</i> , LOW: 0V; HIGH: +U _B -1V; max. 100 mA** |
| 7 (GND) | 0 V |
| 8 (+U _B) | 18...28 VDC, max. 500mA |

Tab. 11: Spezifikation Sensorbuchse SB2/ Specification sensor connector SB2

| Pin | Spezifikation/ <i>Specification</i> |
|----------|---|
| 1 (OUT1) | Gegentakt/ <i>Push-Pull</i> , LOW: 0V; HIGH: +U _B -1V; max. 100 mA |
| 2 (OUT2) | Gegentakt/ <i>Push-Pull</i> , LOW: 0V; HIGH: +U _B -1V; max. 100 mA |
| 3 (OUT3) | Gegentakt/ <i>Push-Pull</i> , LOW: 0V; HIGH: +U _B -1V; max. 100 mA |
| 4 (OUT4) | Gegentakt/ <i>Push-Pull</i> , LOW: 0V; HIGH: +U _B -1V; max. 100 mA |
| 5 (OUT5) | Gegentakt/ <i>Push-Pull</i> , LOW: 0V; HIGH: +U _B -1V; max. 100 mA |
| 6 (OUT6) | Gegentakt/ <i>Push-Pull</i> , LOW: 0V; HIGH: +U _B -1V; max. 100 mA |
| 7 (OUT7) | Gegentakt/ <i>Push-Pull</i> , LOW: 0V; HIGH: +U _B -1V; max. 100 mA |
| 8 (OUT0) | Gegentakt/ <i>Push-Pull</i> , LOW: 0V; HIGH: +U _B -1V; max. 100 mA |

* / ** siehe Seite 9 / *see page 9*

Drift Verhalten und Geräteübereinstimmung/
Drift behavior and Inter-Instrument agreement

Tab. 12: Charakteristik/ *Characteristics*

| | | |
|---|------|--------|
| Langzeitdrift ¹⁾ / <i>Long-term drift ¹⁾</i> | 0,02 | DE/day |
| Temperaturdrift/ <i>Temperature drift</i> | 0,05 | DE/°C |

1) Testbedingungen siehe Tab. 13/ *Test conditions see Tab. 13*

Diagramme/ *Diagrams*

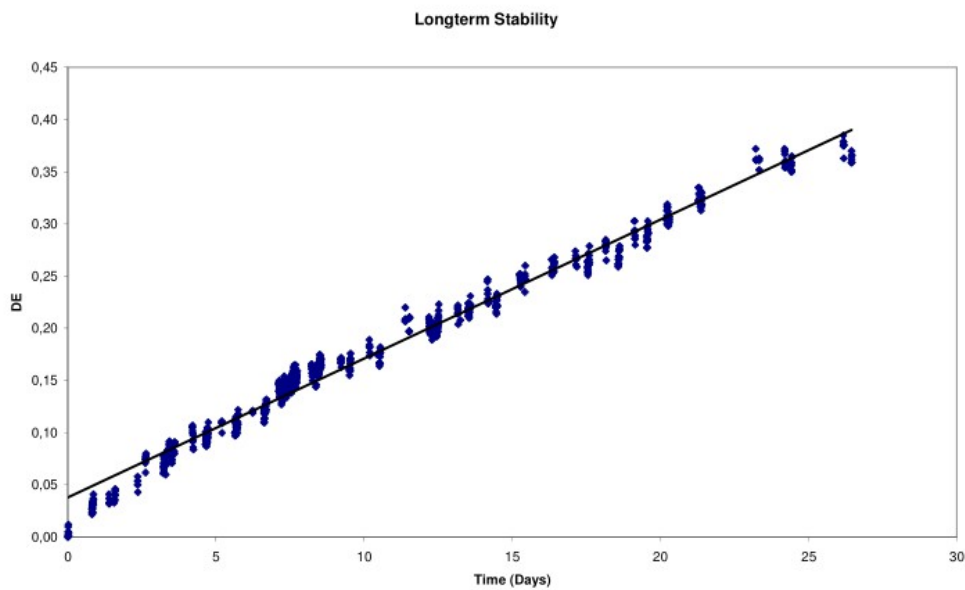

Fig. 4: Typische Langzeitdrift/ *Typical long-term drift*

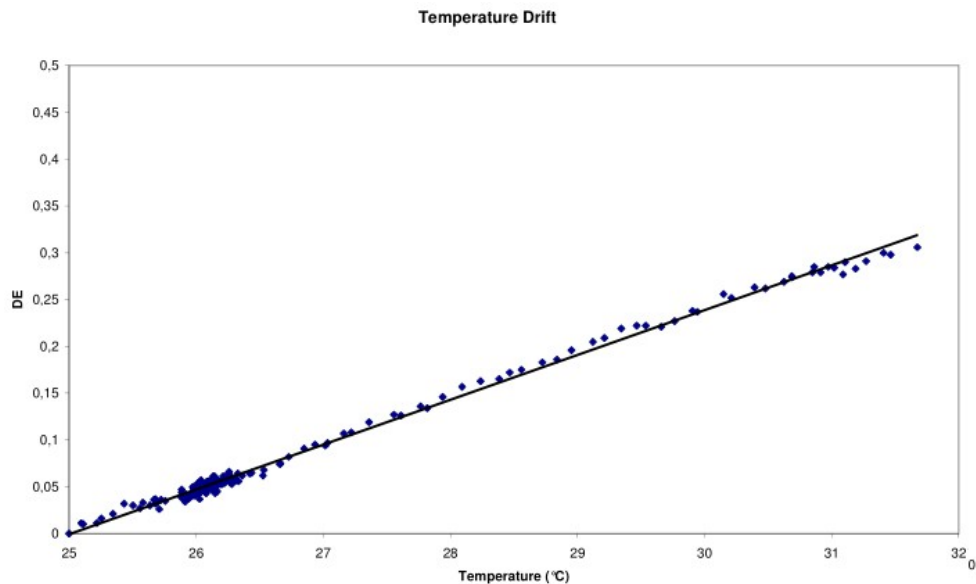

Fig. 5: Typische Temperaturdrift/ *Typical temperature drift*

Tab. B: Testbedingungen für Langzeitdrift/ *Test conditions for long-term drift*

| | |
|--|---|
| Referenzobjekt/ <i>Reference object</i> | RAL9003-HR (Signalweiß, <i>signal white</i>) |
| Schnittstelle/ <i>Interface</i> | RS232 |
| Abstand Faser <-> Objekt/ <i>Distance fiber <-> object</i> | 5 mm |
| Fasertyp/ <i>Fiber type</i> | FAR-M-C2.0-2,5-1200-67° |
| Intensität/ <i>Intensity</i> | 36 (14,12%) |
| Verstärkung/ <i>Gain</i> | 25 |
| Abtastfrequenz/ <i>Scan frequency</i> | 100 Hz |
| Gehäusetemperatur/ <i>Case temperature</i> | (25 ± 0.2)°C |
| Farbmodus/ <i>Color mode</i> | L*a*b* |

Tab. I4: Geräteübereinstimmung ²⁾/ *Inter-Instrument agreemen* ²⁾

| | |
|--|--------|
| mittlere Abweichung ohne Abgleich/ <i>mean deviation w/o balance</i> | < 3 DE |
| mittlere Abweichung nach Abgleich/ <i>mean deviation after balance</i> | < 1 DE |

2) Verwendetes Farbtarge/ *Used color target*: GretagMacbeth ColorChecker Color Rendition Chart

Aufwärmverhalten/ *Warming up*

Fig. 6 zeigt typische XYZ Signale nach dem Einschalten des Sensors bei konstanter Gehäusetemperatur./ *Fig. 6 shows typical XYZ signals after switching on the sensor for const. case temperature.*

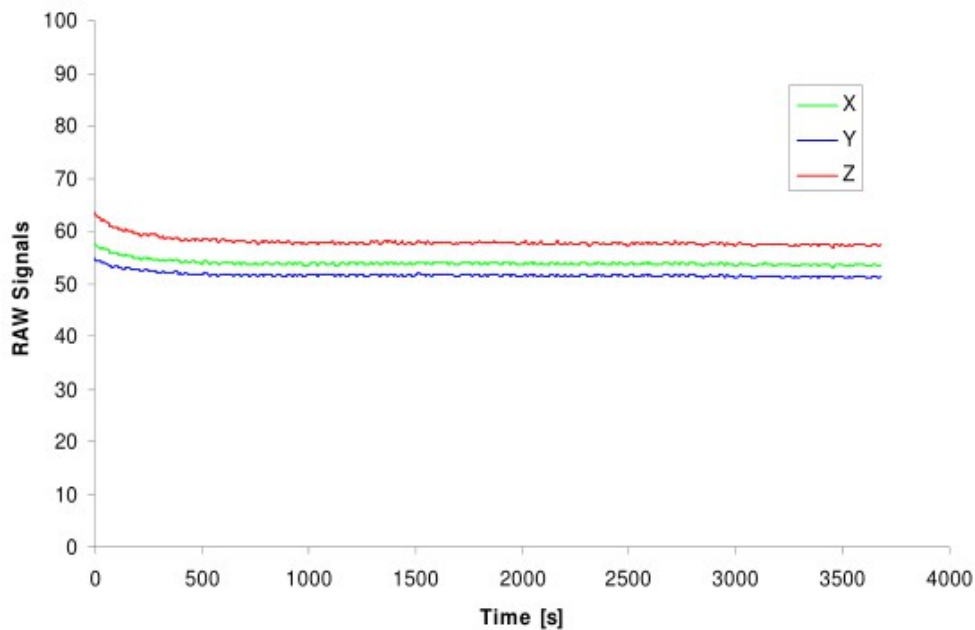

Fig. 6: Aufwärmverhalten/ *Warming up*

Bestellnummern/ *Ordering numbers*

| Artikel/ <i>Item</i> | Bestellnummer/ <i>Order Number</i> |
|---|---|
| PCS-II Farbsensor/ <i>PCS-II color sensor</i> | 11-1001-03 |
| 8 pol. Anschlusskabel/ <i>8-way connector cable, 2m</i> | 13-1000-01 |
| RS232 Anschlusskabel/ <i>RS232 connector cable, 2m</i> | 13-1001-01 |
| USB Anschlusskabel/ <i>USB connector cable, 2m</i> | 13-1002-01 |
| Schutzkappe/ <i>Protection cap</i> | 13-1003-02 |
| Lichtleiter/ <i>Fiber optics</i> | Lichtleiterprospekt/ <i>fiber optics brochure</i> |
| PCS-Control Box (Parametriergerät/ <i>Parametrization device</i>) | 12-1005-01 |

Bemerkungen/ *Comments*

- * **N.C.** für die Seriennummern/ *for serial number*: XXXXXX-1-XXX(**1-9, A**)-XXXXXXXX
- ** **OUT** ab Seriennummer/ *starting from serial number*: XXXXXX-1-XXX**B**-XXXXXXXX:
Die Ausgänge OUT0, OUT1, OUT2 stehen jetzt auch an SB1 zur Verfügung. Diese sind elektrisch mit SB2 verbunden und zeigen das selbe Ausgangsverhalten wie die gleichnamigen Ausgänge an SB2./

OUT0, OUT1, OUT2 (SB1) are identical to OUT0, OUT1, OUT2 (SB2)



Sicherheitshinweise

Diese Geräte sind nicht zulässig für Sicherheitsanwendungen, insbesondere bei denen die Sicherheit von Personen von der Gerätefunktion abhängig ist. Der Einsatz der Geräte muss durch Fachpersonal erfolgen.
Reparatur nur durch Silicann Systems.



Safety instructions

*The instruments are not to be used for safety applications, in particular applications in which safety of persons depends on proper operation of the instruments. These instruments shall exclusively be used by qualified personnel.
Repair only by Silicann Systems.*

Änderungen vorbehalten



SIUCANN Systems GmbH
Schillerplatz 10 · 18055 Rostock / Germany
Tel. +49 (0) 381 3676412-0 · Fax +49 (0) 381 3676412-9
info@silicann.com · www.silicann.com